

SPECIFICATION



DC IMMUNE Current Transformer

Model No ; **HDC-4P**

Type ; Standard Type

DIMENSION

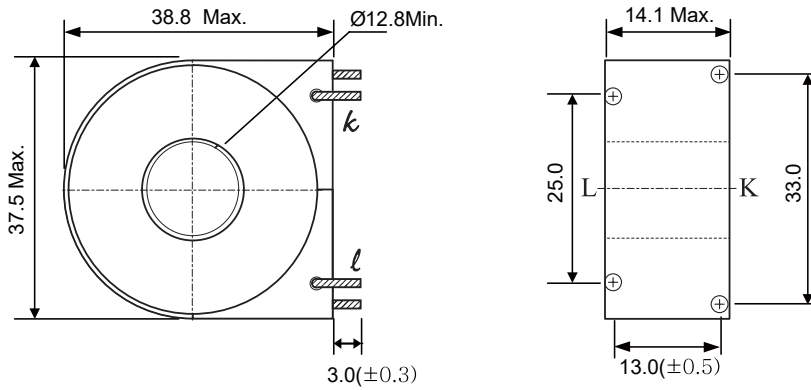

CHARACTERISTICS

At 50/60hz

ITEM	PROPERTY	CONDITION
CURRENT RATIO	2500:1	
RATED CURRENT	120A / 48mA	at No Load
OUT PUT(E ₂)	480mV	IN PUT 120A, at Load R=10 Ω
RATIO ERROR	0.2% max.	PRIMARY RATED'S (100%~3.33%) (A/C Current Range)
PHASE ANGLE ERROR	0.2° max.	PRIMARY RATED'S (100%~3.33%) (A/C Current Range)
DC INPUT PROPERTY	3% max.	ERROR RATIO at an input half wave rectification of primary (rated current/ $\sqrt{2}$)

TEST DIAGRAM

