

SPECIFICATION



Accuracy Grade Current Transformer

Model No ; **H-2V**

Type ; Standard Type

DIMENSION

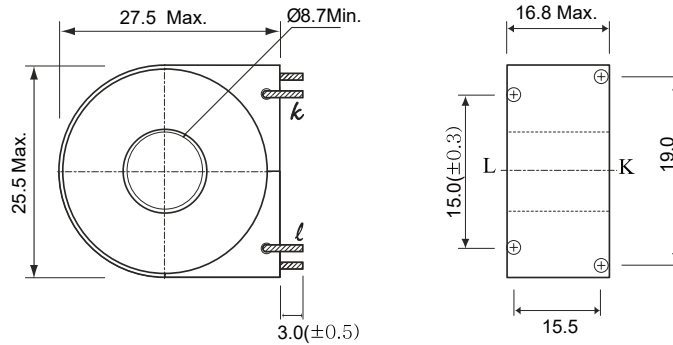

CHARACTERISTICS

ITEM	PROPERTY	CONDITION
CURRENT RATIO	2500:1	
RATED CURRENT	60A / 24mA	at No Load
OUT PUT(E ₂)	240mV	IN PUT 60A, at Load R=10Ω
RATIO ERROR	0.2% max.	PRIMARY RATED'S (100%~1.67%)
PHASE ANGLE ERROR	0.2° max.	PRIMARY RATED'S (100%~1.67%)

TEST DIAGRAM

