

# SPECIFICATION

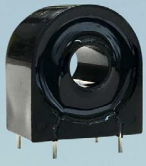

## Accuracy Grade Current Transformer

Model No ; **H-1V, 4P**

Type ; Standard Type

## DIMENSION

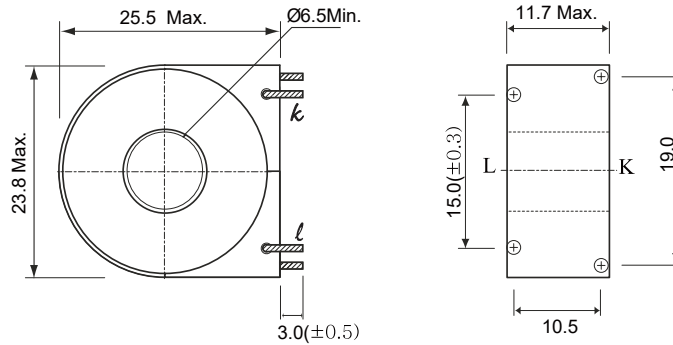

## CHARACTERISTICS

ITEM	PROPERTY	CONDITION
CURRENT RATIO	2500:1	
RATED CURRENT	5A / 2mA	at No Load
OUT PUT(E <sub>2</sub> )	20mV	IN PUT 5A, at Load R=10Ω
RATIO ERROR	0.2% max.	PRIMARY RATED'S (100%~1.67%)
PHASE ANGLE ERROR	0.2° max.	PRIMARY RATED'S (100%~1.67%)

## TEST DIAGRAM

